

S-BT-GF M8/7 AN 6  
S-BT-GF NG M8/7 AN 6  
S-BT-MF MT M8/7 AN6

	SBT 4-A22
	TS-BT 5.5-74 S TS-BT 5.5-110 S
	SBT 4-A22 SFC 18/22-A
	S-DG BT M8/7 Short 6
	S-CC BT 6
	Flange nut M8-F wide

Torque tool X-BT 1/4"  
8 Nm / 5.9 ft.lb

S-NS 13 C 95/3 3/4"

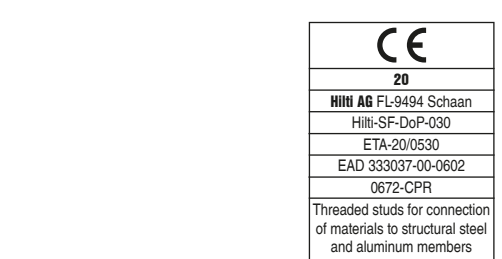
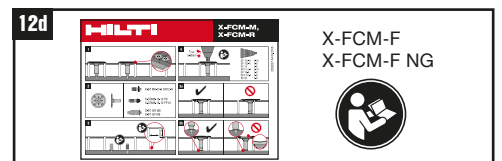
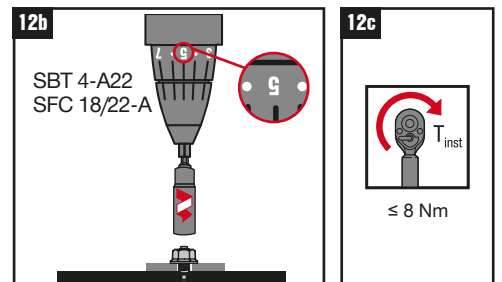
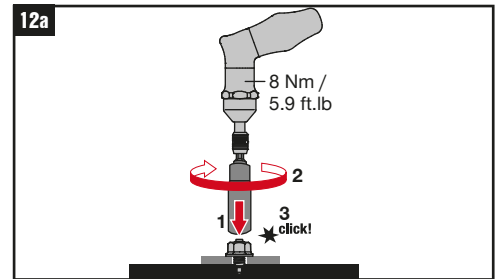
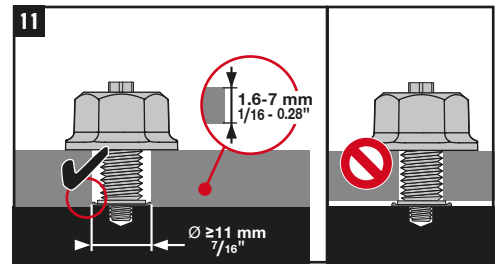
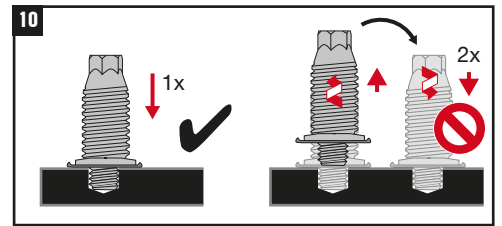
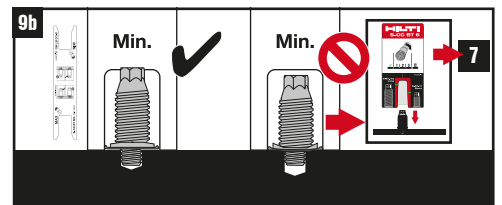
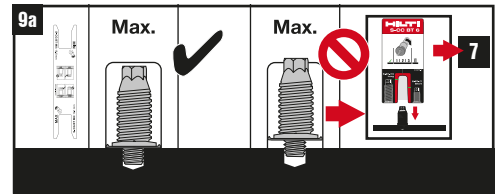
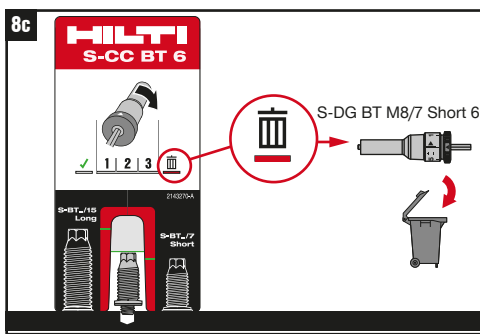
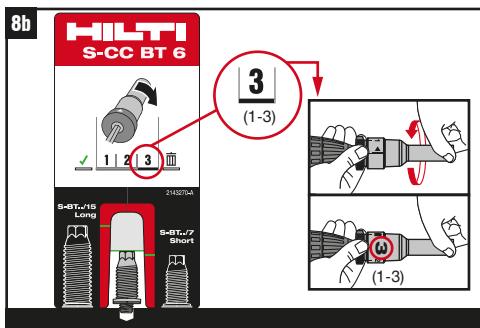
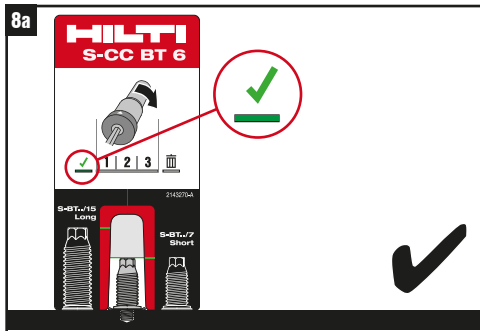
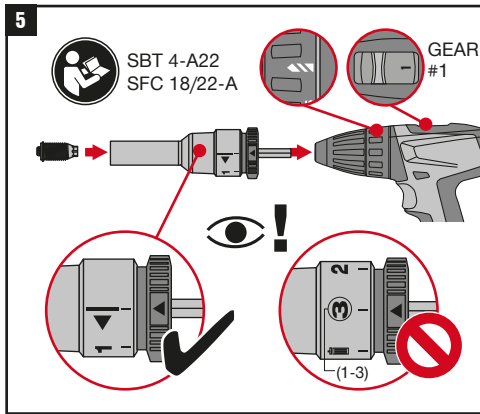
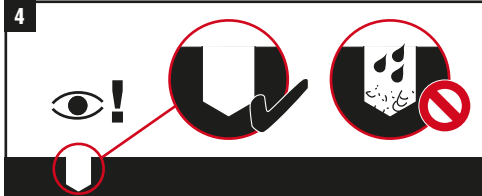
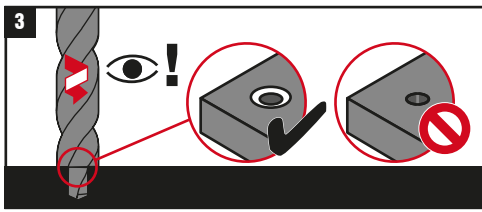
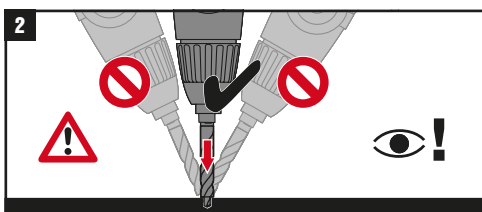
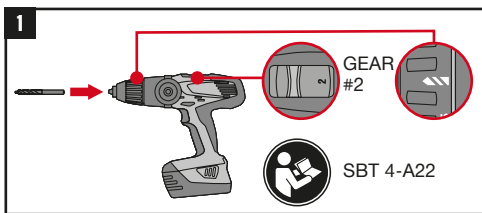

CE  
20  
HILTI AG FL-9494 Schaan  
HilTI-SF-DoP-030  
ETA-20/0530  
EAD 333037-00-0602  
0672-CPR  
Threaded studs for connection of materials to structural steel and aluminum members